

### PRODUCT SPECIFICATIONS

Elkay Weldbilt Stainless Steel 49-1/2" x 27-1/2" x 14" Floor Mount, Single Compartment Scullery Sink with Drainboard. Sink is manufactured from 14 gauge 304 Stainless Steel with a Buffed Satin finish, Center drain placement. Sinks supported by (4) 16 gauge stainless steel, 1-5/8" O.D. tubular legs with bullet shaped feet adjustable up to 1".

<b>Material:</b>	304 Stainless Steel
<b>Finish:</b>	Buffed Satin
<b>Gauge:</b>	14
<b>Number of Bowls:</b>	1
<b>Sink Dimensions:</b>	49-1/2" x 27-1/2" x 44"
<b>Bowl 1 Dimensions:</b>	24" x 24" x 14"
<b>Drainboard Location:</b>	Right
<b>Drainboard Size:</b>	24
<b>Backsplash Height:</b>	8
<b>Leg Type:</b>	Stainless Steel
<b>Drain Size:</b>	3-1/2" (89mm)
<b>Drain Location:</b>	Center

<b>Custom Options</b>	
<input type="checkbox"/> Type 316 Stainless Steel	
<b>Drain Location</b>	
<input type="checkbox"/> Right Rear	<input type="checkbox"/> Left Rear
<input type="checkbox"/> Center	<input type="checkbox"/> Center Rear
<b>Overflow Location</b>	
<input type="checkbox"/> Front	<input type="checkbox"/> Left
<input type="checkbox"/> Rear	<input type="checkbox"/> Right
<b>Alternate Punching</b>	
<input type="checkbox"/> Faucet Model:	<input type="checkbox"/> Punch Required:
<b>Sink Size</b>	
<input type="checkbox"/> Bowl Width:	<input type="checkbox"/> Drainboard Width:
<input type="checkbox"/> Bowl Depth:	<input type="checkbox"/> Backsplash Height:

\*Options available if applicable

\*\*Drainboards over 25-1/2" wide furnished with one tubular leg.

\*\*\*Drainboards over 48" wide furnished with two tubular legs.



AMERICAN PRIDE. A LIFETIME TRADITION. Like your family, the Elkay family has values and traditions that endure. For almost a century, Elkay has been a family-owned and operated company, providing thousands of jobs that support our families and communities.



**Product Compliance:** ASME A112.19.3/CSA B45.4  
BUY AMERICAN ACT  
NSF 2



[Clean and Care Manual \(PDF\)](#)  
[Limited Warranty \(PDF\)](#)

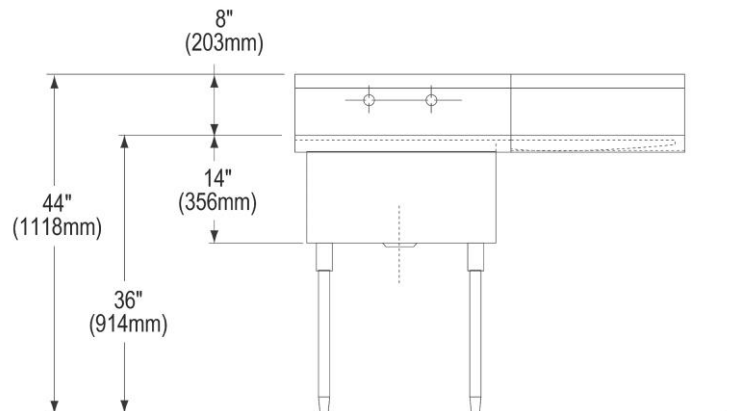
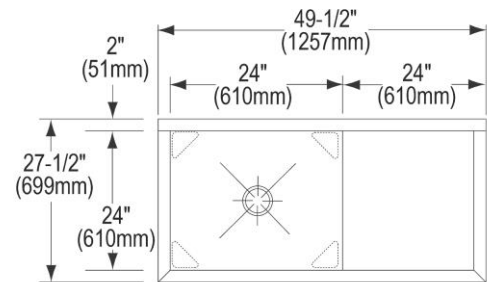

PART: \_\_\_\_\_ QTY: \_\_\_\_\_

PROJECT: \_\_\_\_\_

CONTACT: \_\_\_\_\_

DATE: \_\_\_\_\_

NOTES: \_\_\_\_\_

APPROVAL: \_\_\_\_\_

In keeping with our policy of continuing product improvement, Elkay reserves the right to change product specifications without notice. Please visit [elkay.com](http://elkay.com) for the most current version of Elkay product specification sheets. This specification describes an Elkay product with design, quality, and functional benefits to the user. When making a comparison of other producers' offerings, be certain these features are not overlooked.

*In keeping with our policy of continuing product improvement, Elkay reserves the right to change product specifications without notice. Please visit [elkay.com](http://elkay.com) for the most current version of Elkay product specification sheets. This specification describes an Elkay product with design, quality, and functional benefits to the user. When making a comparison of other producers' offerings, be certain these features are not overlooked.*