

CODE NUMBER

3912693

DESCRIPTION

1.5 gpf, Polished Chrome Finish, Single Flush, Royal® Exposed Manual Specialty Urinal Hydraulic Flushometer.

DETAILS

- Flush Volume: 1.5 gpf (5.7 Lpf)
- Finish: Polished Chrome (CP)
- Valve: Diaphragm
- Valve Body Material: Semi-red Brass
- Fixture Type: Urinal
- Fixture Connection: Top spud
- Rough-In Dimension: 11 ½" (292mm)
- Spud Coupling: ¾" (19mm)
- Supply Pipe: ¾" (19mm)

FEATURES

- ADA Compliant Non-Hold-Open feature type Actuator (not included, order separately-specify Actuator type listed below)
- ¾" I.P.S. Screwdriver Bak-Chek® Angle Stop
- Sweat Solder Adapter with Cover Tube and Cast Set Screw Wall Flange
- Spud Coupling and Flange for ¾" Top Spud
- Handle Packing, Main Seat, Stop Seat and Vacuum Breaker Molded from PERMEX® Rubber Compound for Chloramine resistance
- Dual Filtered Bypass Diaphragm



Push Button actuator not included

COMPLIANCES & CERTIFICATIONS

(ADA Compliant, cUPC Certified, BAA Compliant)

RECOMMENDED SPECIFICATION

Valve Body, Cover, Tailpiece and Control Stop shall be in conformance with ASTM Alloy Classification for Semi- Red Brass. Valve shall be in compliance with the applicable sections of ASSE 1037 and ANSI/ASME 112.19.2.

VALVE OPERATING PRESSURE (FLOWING)

15–80 PSI (103–552 kPa). Specific fixtures may require greater minimum flowing pressure - consult manufacturer requirements.

DOWNLOADS

- [Sloan 900 Exposed Installation Instructions](#)
- [Control Stop Repair and Maintenance Guide](#)
- [Flush Connections Flanges Repair and Maintenance Guide](#)
- [Tail Piece Repair and Maintenance Guide](#)
- [Royal Flushometers Repair and Maintenance Guide](#)
- [Series 900 Flushometers Repair and Maintenance Guide](#)
- [Additional Downloads](#)

NOTES

All information contained within this document subject to change without notice.

Looking for other variations of the ROYAL 986 product? [View the general spec sheet with all options.](#)

[Find a compatible urinal](#) for this flushometer.

[Find a compatible water closet](#) for this flushometer.

Sloan 10500 Seymour Ave, Franklin Park, IL 60131

Phone: 800.982.5839 • Fax: 800.447.8329 • sloan.com

ROUGH-IN

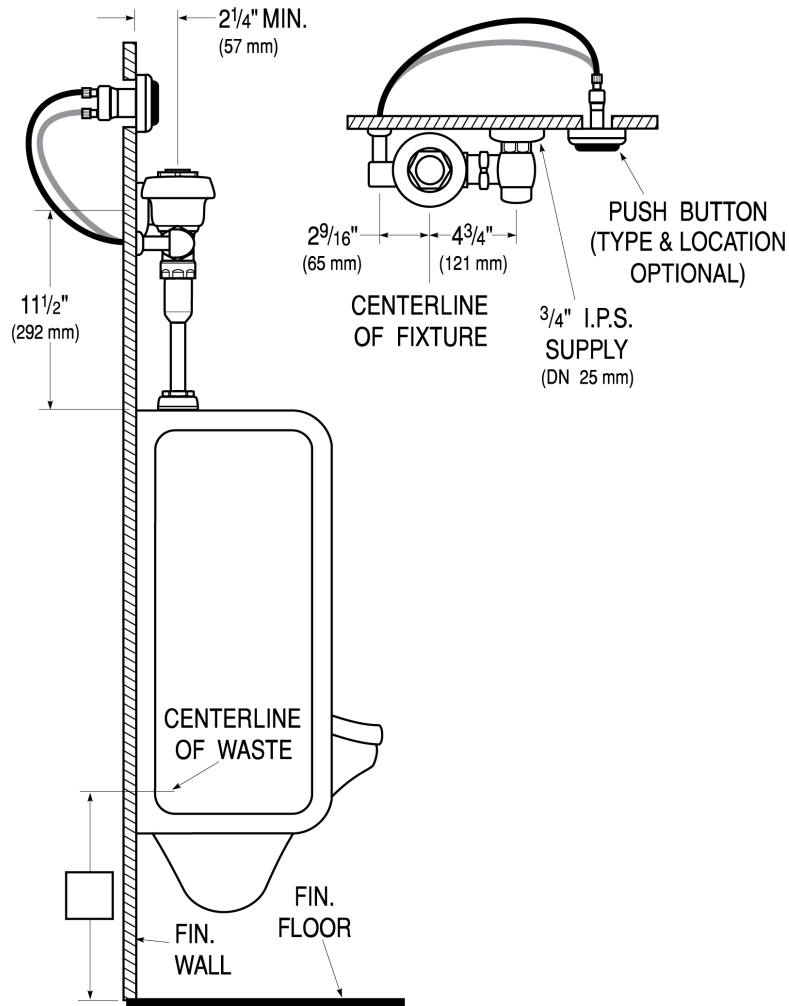

Sloan 10500 Seymour Ave, Franklin Park, IL 60131
Phone: 800.982.5839 • Fax: 800.447.8329 • sloan.com